

EQOair Aluminium Sliding Coupling

Sliding Coupling	Part N.	∅	Fig.	A	E	S	gr.
	8-.012.020	20	A	70,0	37,0	29,0	72,0
	8-.012.025	25	A	75,0	42,0	36,0	96,0
	8-.012.032	32	A	94,0	51,0	43,0	174,0
	8-.012.040	40	A	117,0	63,0	53,0	338,0
	8-.012.050	50	A	138,0	78,5	66,0	554,0
	8-.012.063	63	A	173,0	95,0	82,0	990,0
	8-.012.075	75	A	174,0	108,5	100,0	1.140,0
	8-.012.090	90	A	190,0	132,0	118,0	1.760,0

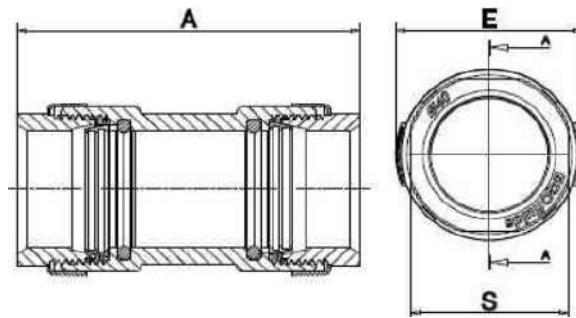

Technical Details

	EQOair					
Standard Colour	RAL 5012					
Max Working Pressure	16 bar					
Plant Testing Pressure 1 hour at 20°C	24 bar					
Quality Testing Pressure 1 hour at 20°C	72 bar					
Production tested percentage	1%					
O.Ring & Lip Gasket Material	NBR 65/75 S.A					
Continuous Service Temperature Limit	-30°C - 120°C					
Aluminium Pipe Mechanical Resistance	According to EN-755-2/2008 standards					
Pipe Material	Aluminium alloy EN AW 6060 - T5 according to EN 755-2/2008					
Pipe Thickness mm	Tube lenght tolerance +0 -0,1%					
Aluminium Fittings Material	Aluminium Alloy EN Aw 6061 T6 / ENAB 42000					
Clamp Ring Material	AISI 304 Stainless Steel					
Threads Standards	BSPT - British standard pipe taper - ISO 7-1					
Pipe Surface treatment	Polyester resin coated					

Components (DN20 - DN90)



1. Nut
2. Identification Ring
3. Clamping Ring
4. O-Ring
5. Body

Components (DN110 - DN160)



1. Half Blocking Ring
2. Lip Seal
3. Clamping Ring
4. Identification Mark Holder
5. Body
6. Bolts

Preperation

Verify the integrity of the pipe section to be inserted in the fitting.
Any scratches on the paint, if not deep, can be eliminated using 300-600 fine emery paper.
Deep dents/scratches can be eliminated only by changing the branch position or by replacing the pipe section.

When necessary, cut the pipe with a neat 90° cut. Carefully deburring the internal and external sharp resulting edges and make an external bevel of 2-4 mm length with a 30° taper.

All pipe supplied should be deburred internally, externally and beveled.

Mark the pipe so to have a reference for its correct insertion into the fitting to make sure it exceeds the gasket.

The table below shows the correct reference lengths.

DN	20	25	32	40	50	63	90
L(mm)	35	38	49	60	76	96	93

Lubricate the marked pipe section.

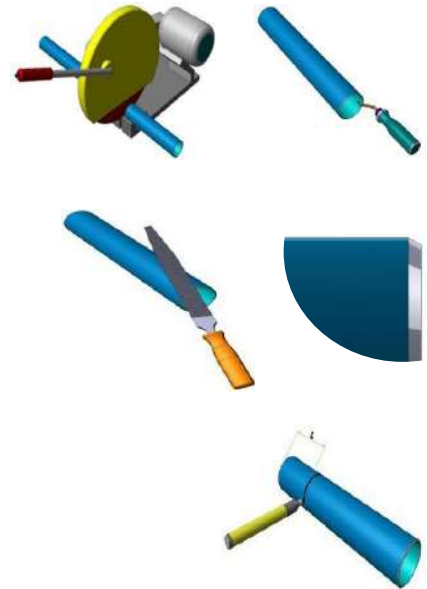

Assembly (DN20 - DN90)

Loosen the nut until the clamp ring is loose.



Ensure the pipe and fittings are parallel to each other.

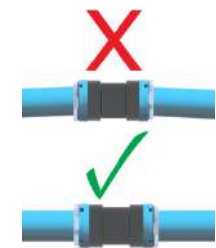

Insert the pipe into the fitting up to align the reference mark with the external nut surface.



Tighten the nut by hand. In this case, the water tightness and axial clamping are ensured.



Sliding Coupling Assembly

First refer to DN20 - DN90 fittings assembly instructions.

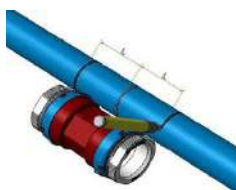

Mark the pipe so to have a reference for its correct insertion into the fitting to make sure it exceeds the gasket. Use the fitting or the follow below table of reference lengths.

DN	20	25	32	40	50	63	90
L(mm)	35	38	49	60	76	96	93

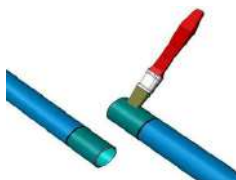

Lubricate the marked pipe section.

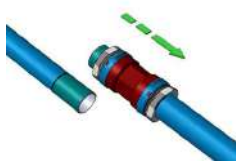

Insert one of the two pipes inside the fitting, until it come out from the other end.

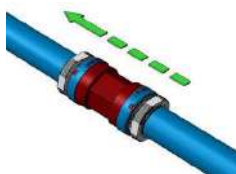

Align the two pipes and slide the fitting until the reference marks are visible.



Tighten the nuts to fix the fitting, following the DN20 - DN90 fittings assembly instructions.